

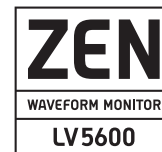

LV5600 WAVEFORM MONITOR

LV7600 RASTERIZER

4K 12GSDI 3GSDI HDSDI
SDSDI IP



General

The LV5600/LV7600 is a hybrid-type waveform monitor and rasterizer compatible with 4K/HD/SD-SDI signal and HD/SD IP signal. The LV5600 is a waveform monitor with a 7-inch touch screen display in a compact 3 U enclosure with built-in AC power supply. The LV7600 is a rasterizer with the same function as the LV5600 in a 1U full rack enclosure. Selection of necessary input signals and functions from various options, and customization to the specification that fits your purpose are possible.

Features

Supports various signal inputs

SDI signals up to 12 G-SDI and IP (video over IP) signals can be observed/monitored. Audio signals can correspond to SDI embedded Audio, Audio multiplexed to IP, external input AES/EBU, analog Audio.

IP input format

The IP signal corresponds to the video signal of the 2K video format at SMPTE ST 2022-6 (non-compression) and SMPTE 2110-20 (non-compression). In 2K video format, up to 2 channels can be received with one 10 Gbit Ethernet cable.

Excellent operability

With the front panel equipped with key buttons and knobs that follow the operability of conventional models, operation with a USB mouse is also possible. In addition, the LV5600 adopts a 7-inch full HD panel with a touch panel function, and the LV7600 can be operated and set intuitively by touch operation by connecting an external LCD adopted touch panel with a USB cable.

* It does not guarantee the operation with the external LCD monitor adopted by all touch panels.

SDI input format

It supports SD-SDI, HD-SDI, 3G-SDI, 12G-SDI single link, 3G-SDI dual link and quad link, HD-SDI quad link.

Transmission quality analysis function

As an SDI signal analysis function, in addition to monitoring of transmission errors, external synchronization phase difference display, lip sync measurement, SDI signal frequency deviation measurement function, an ancillary data analysis function with increased importance as a 4K video signal is also realized. With respect to IP signal measurement, monitoring transmission errors such as packet loss and the transmission quality (QoS) monitoring function such as packet jitter, which was difficult to observe by using IP, are strengthened.

Video analysis function

Various video signals include video signal waveform display, vector display, picture display 5 BAR display, CIE chromaticity diagram display, etc. In addition to the various displays, freeze error, Black error, gamut error detection Functions etc. Quality control (QoE) of video signals Features are equipped.

xy chromaticity coordinate display

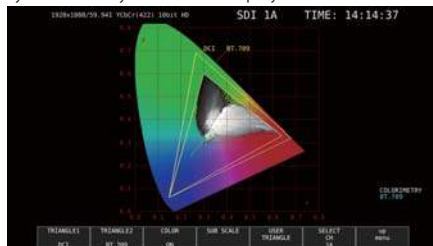

Audio analysis function

For audio signals, SDI signals and audio signals superimposed on IP signals can be displayed on a level meter. Furthermore, Lissajous display, mute, clip error detection, loudness easurement, etc. are available. Audio format is compatible with L-PCM. Also, Dolby E, Dolby Digital, Dolby Digital Plus decode display is possible.

* Dolby and Dolby Digital, Dolby Digital Plus, Dolby E are registered trademarks of Dolby.Z

Eye pattern display

From SD-SDI to 12G-SDI

In the physical layer measurement of the SDI signal some eye pattern display, jitter display is possible.

Eye pattern

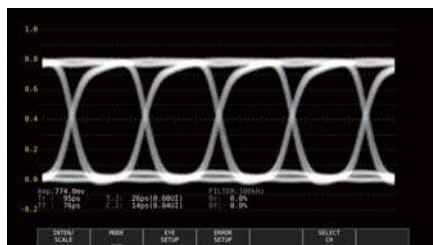

Subtitles/closed caption decode display function

Japanese subtitles and CEA-608, CEA-708 closed caption, Teletext, OP47 subtitle superimposed on SDI signal can be decode displayed.

External synchronization signal input

The phase difference and synchronization status of the SDI signal graphically based on the external synchronization signal (black burst, tri-level sync) can be confirmed.

Also, since the input external sync signal can be displayed as a waveform, it is useful for early detection of problems owing to the synchronization signal.

Customizable layout

Various items such as video signal waveforms, vector waveforms, and pictures of input signals can be laid out in any position with your favorite size.

SDI signal generation function

SDI signal generation function can handle from HD-SDI to 12G-SDI. HD multiformat color bar and pattern corresponds to the multiple overlays of moving boxes and embedded audio, flat field pattern can be specified at any level, multiformat color bar 4K can be selected.

External monitor output

Since the measurement screen can be output as SDI and TMDS from the monitor output terminal, it can be displayed on an external SDI monitor or HDMI monitor with full HD resolution.

* It does not guarantee operation with all HDMI monitors.

Capture function

It equips with a screen capture function to capture the display screen as still image data and a frame capture function to capture 16 frames of data.

Time code display

The time code superimposed on SDI signals and IP signals can be displayed. The time code can also be used as the timestamp of the event log.

External remote terminal

The presets can be recalled by contact terminals, and switching input signals and tally displays and outputting alarms can be conducted.

Ethernet terminal

By connecting to the PC, remote operation by TELNET, file transfer by FTP, remote operation by SNMP and alarm notification, remote operation and monitoring from the browser via HTTP can be done.

HDR

The HDR signal level monitoring and the level management at the assumed luminance (cd /m2) in a display considering OOTF are possible. The video signal waveform display corresponds to the HDR scale added to the IRE scale. In the cine zone display, the luminance distribution of the HDR area can be easily confirmed at the state where the SDR area is monochrome, the HDR is colored according to the brightness.

HDR zone display

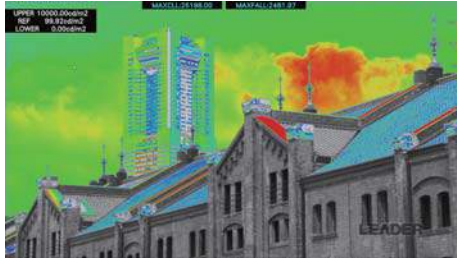

Focus Assist

We developed a new focus detection algorithm based on nonlinear super-resolution technology; accordingly the focus with high sensitivity can be detected even with low-contrast images, which were conventionally difficult to detect.

Tally display

Serial communication enables to display camera ID, iris and tally.

Options

List of hardware options

Model Name	Type Number		Function
	LV5600	LV7600	
SDI INPUT	LV5600-SER01	LV5600-SER01	SD, HD, 3G SDI input *1
SDI INPUT/EYE	LV5600-SER02	LV5600-SER02	SD, HD, 3G SDI input and eye pattern display *1
DIGI/ANA AUDIO	LV5600-SER03	LV7600-SER03	Digital/analog Audio input/output and display
DOLBY	LV5600-SER04	LV7600-SER04	Dolby Digital, Dolby E decode function *2
IP INPUT	LV5600-SER05	LV7600-SER05	IP INPUT *1

*1 For LV5600, either LV5600-SER01 or LV5600-SER02 is selected, but either one of LV5600-SER01, LV5600-SER02, LV5600-SER05 is necessary.

Either LV5600-SER01 or LV5600-SER02 is selected for LV7600, but either one of LV5600-SER01, LV5600-SER02, LV7600-SER05 is necessary.

*2 LV5600-SER03 is required for LV5600. LV7600 requires LV7600-SER03.

Software option list

Model Name	Type Number		Function
	LV5600	LV7600	
AUDIO	Equipped with LV5600-SER03	Equipped with LV7600-SER03	AUDIO display function
CLOSED CAPTION	Standard equipment	Standard equipment	Japanese subtitles, EIA-608, 708, TELETEXT
CIE	Standard equipment	Standard equipment	CIE chart display function *3
HDR	LV5600-SER23	LV7600-SER23	HDR measurement function
TSG	LV5600-SER24	LV7600-SER24	SDI signal generation function
FOCUS ASSIST	LV5600-SER25	LV7600-SER25	Focus assist display Function
LAYOUT	LV5600-SER26	LV7600-SER26	Customizable layout function
TALLY	LV5600-SER27	LV7600-SER27	ID/iris/tally display function
4K	LV5600-SER28	LV7600-SER28	4K video signal correspondence function
12G-SDI	LV5600-SER29	LV7600-SER29	12G-SDI compatible *

* LV5600 requires LV5600-SER28. LV7600 requires LV7600-SER28.

LV5600-SER01, SDI Input

LV5600-SER02, SDI input with eye pattern

LV5600-SER01 is a unit that can display various SDI signals.
(LV5600, LV7600 common unit)

• Video analysis function

Various types of video signals, in addition to a variety of displays such as video signal waveform displays, vector display, picture display, 5 BAR display, the CIE chromaticity diagram and CINELITEII., video signal quality (QoE) freezes error, error black, gamut error detection, etc. are equipped as standard equipment.

• Audio analysis function

The audio signal embedded in SDI signals can be displayed on a level meter.

* Lissajous, surround and status can be displayed by adding LV5600-SER03/LV7600-SER03

• SDI signal data analysis function

The status display has an error detection function of CRC and embedded sound. It also has an event log, data dump, phase difference measurement functions, and can analyze SDI signals.

• Screen capture function

A screen capture function to capture the display screen as still image data and a frame capture function to capture 16 frames of data are equipped. The captured data can be saved in BMP format in comparison with the input signal, as well as the display on the main body, and thus confirmation with the personal computer is possible.

• Frame Capture function

A flame capture function to capture 16 frames of the SDI signals is equipped. There are two methods; one is to import them manually and another is to take them automatically when an error occurs.

* Only one frame is captured when an error occurs.

• Frame capture viewer (free Windows software)

Search for data captured by the frame capture function, error search, and export to CSV are possible.

• Time code display

The time code superimposed on SDI signals and can be displayed. The time code can also be used as the timestamp of the event log.

• Input/output terminal

SDI input terminal BNC connector 4 terminal

SDI output terminal BNC connector 4 terminal
(main unit standard equipment)

Output reclock signal The SDI signal of the input terminal is reclock output to the output terminals, respectively.

Output terminal 1 can switch the signal of the input terminal and can reclock output.

• Audio level meter (8ch)

Embedded audio SMPTE ST 299, SMPTE ST 272
48 kHz/24 bit/L-PCM

Synchronization condition All are synchronized with the video clock. All input SDI signals are synchronized.

* When LV5600-SER03/LV7600-SER03 is added, it corresponds to 16 channels.

• Closed caption display function

CEA-608, CEA-708 closed caption, Teletext, OP47 subtitle superimposed on SDI signal can be decode displayed.

• Japanese subtitle simplified display function

Japanese subtitles are simply displayed on the picture screen (HD, SD, analog), portable subtitles are selected/displayed. Language 1 and 2 are selected/displayed.)

Approved standard

Japanese subtitle simplified display



• CIE chart display function

This is a chromaticity diagram display function corresponding to colorimetry ITU- R BT. 601, ITU- R BT. 709, ITU- R BT. 2020. The display mode corresponds to CIE 1931 (xy display) and CIE 1976 (u'v' display). Since the CIE chart display function can display two color gamuts, the function can be used to suppress the color gamut of BT.709 using the equipment compatible with BT.2020, and to confirm the content that exceeds the color gamut of BT.709. In color display, the chromaticity point is displayed using the color (on the picture) in the video signal. The chromaticity point can be measured at the point with the cursor.

xy chromaticity coordinate display

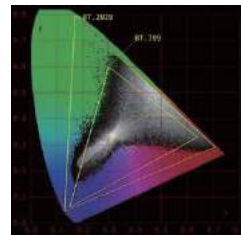

u' v' chromaticity coordinate display

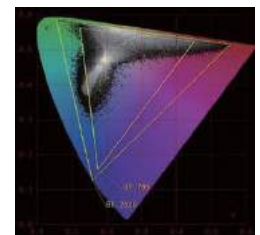

xy coordinate color indication

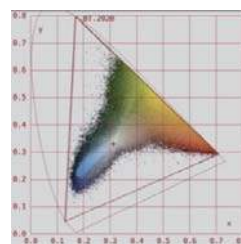

A light blue is a measurement function cursor

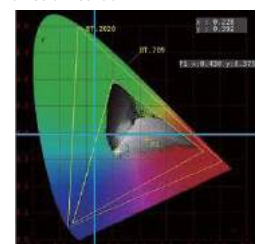

• Eye pattern display (LV5600-SER02/LV7600-SER02)

SThe eye pattern waveform, jitter waveform of SDI signal, and the measurement result of each parameter can be displayed.

Only input terminal 1 corresponds to eye pattern display.

Eye pattern display

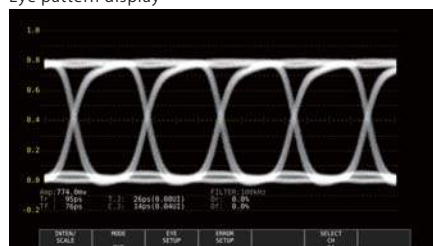

LV5600-SER03 / LV7600-SER03,

Digital and analog audio I/O and displays (16 ch)

- Audio analysis

Lissajous display, surround display, mute, clip error detection, loudness measurement, etc. are now available. Various analysis display is also possible, and simultaneously display of 16 channels from one SDI signal and 4 channels from 4 SDI signals is possible.

- Embedded Audio

Approved standard SMPTE ST 299, SMPTE ST 272
48 kHz/24 bit/L-PCM

Synchronization condition All are synchronized with the video clock. All input SDI signals are synchronized.

- External input audio

Approved standard AES-3id

Synchronization condition All external input audios are synchronized with each other.

- Digital audio input/output Terminal

Input/output terminal DIN 1.0/2.3 connector

Number of Input/output terminals

Group A 4 terminals 8ch

Group B 4 terminals 8ch

Switching input/output Switching by each group
(4 terminals 8 ch)

LV5600-SER04 / LV7600-SER04, Dolby decoding function

Decoding display of Dolby E, Dolby Digital, Dolby Digital Plus becomes possible by adding LV5600-SER 04 and LV7600-SER 04 to LV5600-SER 03 and LV7600-SER 03.

Audio display

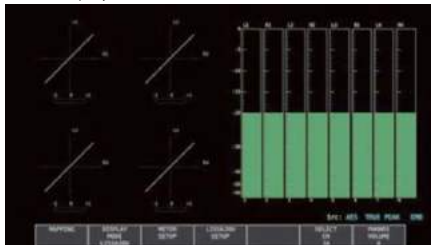

LV5600-SER05 / LV7600-SER05,

IP input (SMPTE ST 2022- 6, SMPTE 2110- 20)

It corresponds the IP signal and the video signal of the 2K video format at SMPTE ST 2022-6 (non-compression) and SMPTE 2110-20 (non-compression).

- Video analysis function

Various types of video signals, in addition to a variety of displays such as video signal waveform displays, vector display, picture display, 5 BAR display, the CIE chromaticity diagram and CINELITEII, video signal quality (QoE) freezes error, error black, gamut error detection, etc. are equipped.

- Audio analysis function

The audio signals superimposed on IP signals can be displayed on a level meter.

- Transmission quality analysis function

Together with monitoring transmission errors such as packet loss, check sum error, packet discontinuity, the transmission quality (QoS) monitoring function such as packet jitter, which was difficult to observe by using IP, are strengthened.

- Capture function

A screen capture function to capture the display screen as still image data is equipped. It also has a frame capture function and can capture one frame of an active video period.

- Time code display

The time code superimposed on IP signals and can be displayed. The time code can also be used as the timestamp of the event log.

- Input video format

Corresponding IP standard SMPTE ST 2022- 6, SMPTE ST 2110- 20
Supported format 1080 (60, 59.94, 50 I/P),
720 (60, 59.94, 50 I/P) , 576 (50I) ,
487 (59.94I) , (YCBCRY4:2:2/10 bit)

- Input audio format

Approved standard SMPTE ST 2022- 6, SMPTE ST 2110- 30

Sampling frequency 48 kHz

Quantization accuracy 24 bits

Supported formats L-PCM/Dolby-E/Dolby Digital/Dolby Digital Plus.

Clock generation method Generated from video clock

Synchronization condition Synchronized with video signals.

The maximum 16 channels of IP audio separation channels are separated/displayed.

* L-PCM requires optional mounting of LV5600-SER 03 and LV7600-SER 03.

* Dolby correspondence requires optional mounting of LV5600-SER03/04, LV7600-SER03/04.

- Input terminal

Input terminal SFP +

Number of terminals 2

Approved standard 10GBASE-SR/10G BASE-LR

* SFP + transceiver is an optional item.

- Auxiliary data

Approved standard SMPTE ST 2110-40

LV5600-SER23 / LV7600-SER23,
HDR measurement function

In addition to HLG and PQ provided by ITU-R BT.2100, the level monitoring of the HDR signal corresponding to S-log3 and the level management at the assumed luminance (cd/m²) in a display considering OOTF are possible. The video signal waveform display corresponds to the HDR scale added to the IRE scale. In the cine zone display, the luminance distribution of the HDR area can be easily confirmed by displaying the SDR area with monochrome, and the HDR with a color according to the brightness.

• HDR zone display

The luminance distribution of the HDR area can be easily confirmed by coloring the SDR area with monochrome, and the HDR with a color according to the brightness.

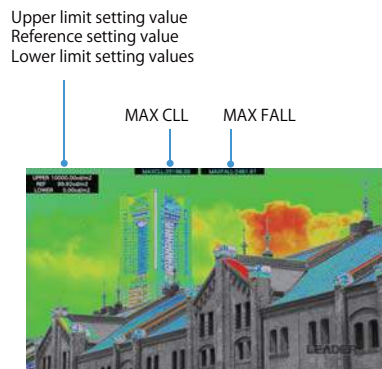

- The SDR part is monochrome, the HDR region is colored according to luminance.
- Above the upper limit value is colored with magenta.
- The upper limit value, the reference value, the lower limit value can be varied

• HDR Scale

By associating WFM and histogram with HDR scale, management of the video with brightness at the time of scene linearity is possible.

• HDR waveform display

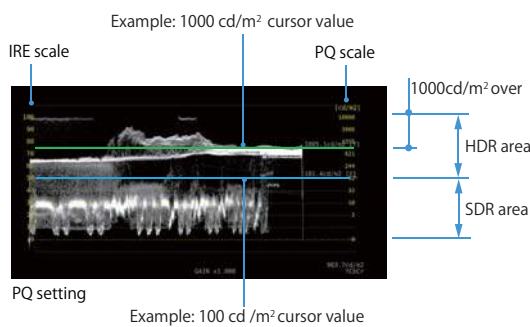

• HDR point measurement

- The crosshairs can be freely moved.
- Up to 3 points can be measured simultaneously.



PQ setting
P1(S: 884, L: 261) 3243.6cd/m2

HLG setting SYSTEM GAMMA OFF
P1(S: 884, L: 261) 623.9%

HLG setting System Gamma On
P1(S: 884, L: 261) 456.1cd/m2

S-Log3 setting System Gamma Off
P1(S: 884, L: 261) 809.1%

• Approved standard

ITU-R BT. 2100 (HLG, PQ), S-Log 3

• Supported format

It corresponds to all except SD and XYZ input of SDI.

LV5600-SER24 / LV7600-SER24,

SDI signal generation function

SDI signal generation function can handle from HD-SDI to 12G-SDI. Simplified UHDTV multi-format color bar and pattern corresponds to the multiple overlays of moving boxes and embedded audio, flat field pattern can be specified at any level, multiformat color bar 4K can be selected.

With the 4K pattern of 3G-SDI quad link, the phase of each link can be shifted and output, so confirmation of the pull-in margin of the receiving device is possible.

* When outputting 3G (DL) -4K signal and 3G (QL) -4K signal, LV 5600-SER 28 is required for LV5600 and LV7600-SER 28 is required for LV7600.

* When outputting the 12 G-4 K signal, LV5600 - LV5600 - SER28 and LV5600-SER 29, LV7600 requires LV7600-SER 28 and LV7600-SER 29.

• Output pattern

100% color bar, 75% color bar, HD multi format color bar, ARIB 4K multi format color bar (simple format), color raster, cross hatch, 10 steps, limit lamp, Check field, lip sync pattern.

• Scroll

Direction 8 directions (up and down, left and right, and combinations thereof)

Speed range and unit 4 to 124 dots per frame (field), 4 dot unit.

Moving Box ON/OFF

Color WHITE, YELLOW, CYAN, GREEN, MAGENTA, RED, BLUE, BLACK

Speed 1 to 3

• Embedded Audio

Number of superimposed channels maximum 16 ch

ON/OFF of superimposition ON/OFF in audio group unit

Audio level- 20 dBFS, -18 dBFS, 0 dBFS, Mute

* For horizontal 4096/2048 pixel format at frame rates 60, 59.94, 30, and 29.97 Hz, only 8 channels are multiplexed.

LV5600-SER25 / LV7600-SER25, Focus assist function

This is a focus detection function realizing a new algorithm based on nonlinear super resolution technology. The focus can be detected with high sensitivity even with low-contrast images, which were conventionally difficult to detect. In addition, sensitivity can be selected from 5 levels according to the video scene.

Focus assist display



After focus adjustment
(The green part is the focus adjustment point)

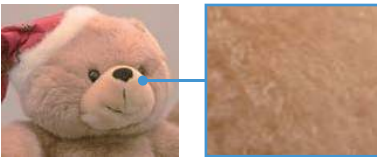

Enlarged view
(After focus adjustment)

LV5600-SER26 / LV7600-SER26, Customizable layout function

• Customizable layout function
Various items such as video signal waveforms, vector waveforms, and images of input signals can be laid out in any position with your preferred size. Multiple input signals up to 4 inputs can be displayed simultaneously, or one input signal can be displayed on multiple screens.

Customizable layout setting screen

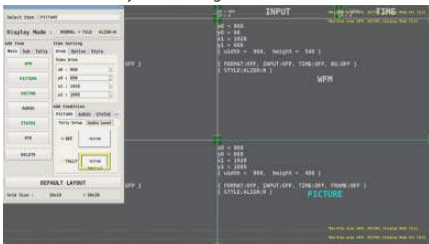

Layout Set measurement screen



• Display channel Function

1SDI input signals of 1 to 4 input terminals can be allocated to A to D display channels.

At this time, by allocating one SDI input signal to multiple display channels, monitoring video signals in multiple display formats is possible.

For example, displaying the signal input to SDI input 1 as component video waveform can be displayed on display channel A and the composite video waveform can be displayed on display channel B.

* It is not possible to monitor errors in the background of input channels not assigned to display channels.

Display channel display image

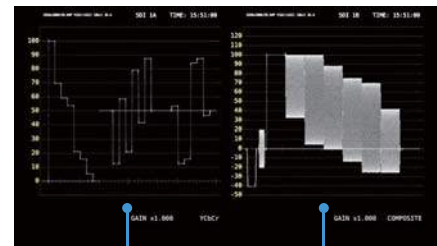

Component Composite

LV5600-SER27 / LV7600-SER27,

ID/iris/tally display function

Serial communication RS-422/485 terminals enable to display camera ID, and tally. Fast switching of tally display by remote terminal is also possible.

ID/iris/tally display screen



LV5600-SER28 / LV7600-SER28,

4K video signal compatible function

It supports 4K video format signals of 3G-SDI dual link and quad link, HD-SDI quad link.

LV5600-SER29 / LV7600-SER29, 12G-SDI compatible

It is compatible with 12G-SDI single link. Also, in the 4K video format, switching up to 4 displays can be done with 12G-SDI single link input, and switching up to 2 displays can be done with 3G-SDI dual link.

*Requires optional mounting of LV5600-SER28 and LV7600-SER28.

LV7290, Remote Controller

The LV7290 remote controller connects to the Ethernet port on the rear panel of the LV5600/LV7600 and can be used to remotely control the LV5600/LV7600. A single unit can connect and control up to eight LV5600/LV7600s.

Dimensions and weight: ≤ 482 (W) X 44 (H) X 110 (D) mm (excluding protrusions), 1.2 kg



SDI video signal format and standard

SD video signal format and standard

Color System	Quantization	Image	Field Frequency / Scanning	Compliant Standard
YCbCr 4:2:2	10bit	720×487	59.94 /I	SMPTE ST 259
		720×576	50 /I	

HD video signal format and standard

Color System	Quantization	Image	Frame (Field) Frequency / Scanning	Compliant Standard
YCbCr 4:2:2	10bit	1280×720	60/59.94/50/	SMPTE ST 292-1
			30/29.97/25/24/23.98 /P	SMPTE ST 296
		1920×1080	60/59.94/50 /I	SMPTE ST 274
			30/29.97/25/24/23.98 /P	SMPTE ST 292-1
			30/29.97/25/24/23.98 /P	
			30/29.97/25/24/23.98 /PsF	

3G-A video signal format and standard

Color System	Quantization	Image	Frame (Field) Frequency / Scanning	Compliant Standard
YCbCr 4:2:2	10bit	1920×1080	60/59.94/50 /P	SMPTE ST 274
			48/47.95 /P	SMPTE ST 425-1
		2048×1080	60/59.94/50/48/47.95 /P	SMPTE ST 425-1
				SMPTE ST 2048-2
			60/59.94/50 /I	SMPTE ST 274
			30/29.97/25/24/23.98 /P	SMPTE ST 425-1
	12bit	1920×1080	60/59.94/50 /I	SMPTE ST 274
			30/29.97/25/24/23.98 /P	
		2048×1080	30/29.97/25/24/23.98 /PsF	SMPTE ST 425-1
			30/29.97/25/24/23.98 /P	
			30/29.97/25/24/23.98 /PsF	
			30/29.97/25/24/23.98 /P	
YCbCr 4:4:4	10bit	1280×720	60/59.94/50/	SMPTE ST 296
			30/29.97/25/24/23.98 /P	SMPTE ST 425-1
		1920×1080	60/59.94/50 /I	SMPTE ST 274
			30/29.97/25/24/23.98 /P	SMPTE ST 425-1
			30/29.97/25/24/23.98 /P	
			30/29.97/25/24/23.98 /PsF	
	12bit	1920×1080	60/59.94/50 /I	
			30/29.97/25/24/23.98 /P	SMPTE ST 425-1
		2048×1080	30/29.97/25/24/23.98 /P	SMPTE ST 425-1
			30/29.97/25/24/23.98 /PsF	SMPTE ST 2048-2
			30/29.97/25/24/23.98 /P	SMPTE ST 425-1
			30/29.97/25/24/23.98 /PsF	SMPTE ST 2048-2
RGB 4:4:4	10bit	1280×720	60/59.94/50/	SMPTE ST 296
			30/29.97/25/24/23.98 /P	SMPTE ST 425-1
		1920×1080	60/59.94/50 /I	SMPTE ST 274
			30/29.97/25/24/23.98 /P	SMPTE ST 425-1
			30/29.97/25/24/23.98 /P	
			30/29.97/25/24/23.98 /PsF	
	12bit	1920×1080	60/59.94/50 /I	
			30/29.97/25/24/23.98 /P	SMPTE ST 425-1
		2048×1080	30/29.97/25/24/23.98 /P	SMPTE ST 425-1
			30/29.97/25/24/23.98 /PsF	SMPTE ST 2048-2
			30/29.97/25/24/23.98 /P	SMPTE ST 425-1
			30/29.97/25/24/23.98 /PsF	SMPTE ST 2048-2
XYZ 4:4:4	12bit	2048×1080	30/25/24 /P	SMPTE ST 372
			30/25/24 /PsF	SMPTE ST 425-1

3G-B-DL, HD(DL) video signal format and standard

Color System	Quantization	Image	Frame (Field) Frequency / Scanning	Compliant Standard
YCbCr 4:2:2	10bit	1920×1080	60/59.94/50 /P	SMPTE ST 274
			48/47.95 /P	SMPTE ST 372
		2048×1080	60/59.94/50/48/47.95 /P	SMPTE ST 425-1
				SMPTE ST 2048-2
			60/59.94/50 /I	SMPTE ST 274
			30/29.97/25/24/23.98 /P	SMPTE ST 372
	12bit	1920×1080	60/59.94/50 /I	SMPTE ST 274
			30/29.97/25/24/23.98 /P	SMPTE ST 372
		2048×1080	30/29.97/25/24/23.98 /PsF	SMPTE ST 425-1
			30/29.97/25/24/23.98 /P	SMPTE ST 372
			30/29.97/25/24/23.98 /PsF	SMPTE ST 425-1
			30/29.97/25/24/23.98 /PsF	SMPTE ST 2048-2
YCbCr 4:4:4	10bit	1920×1080	60/59.94/50 /I	SMPTE ST 274
			30/29.97/25/24/23.98 /P	SMPTE ST 372
		2048×1080	30/29.97/25/24/23.98 /PsF	SMPTE ST 425-1
			30/29.97/25/24/23.98 /P	SMPTE ST 372
			30/29.97/25/24/23.98 /PsF	SMPTE ST 425-1
			30/29.97/25/24/23.98 /PsF	SMPTE ST 2048-2
	12bit	1920×1080	60/59.94/50 /I	SMPTE ST 274
			30/29.97/25/24/23.98 /P	SMPTE ST 372
		2048×1080	30/29.97/25/24/23.98 /PsF	SMPTE ST 425-1
			30/29.97/25/24/23.98 /P	SMPTE ST 372
			30/29.97/25/24/23.98 /PsF	SMPTE ST 425-1
			30/29.97/25/24/23.98 /PsF	SMPTE ST 2048-2
RGB 4:4:4	10bit	1920×1080	60/59.94/50 /I	SMPTE ST 274
			30/29.97/25/24/23.98 /P	SMPTE ST 372
12bit	1920×1080	60/59.94/50 /I	SMPTE ST 274	
		30/29.97/25/24/23.98 /P	SMPTE ST 372	
	2048×1080	30/29.97/25/24/23.98 /PsF	SMPTE ST 425-1	
		30/29.97/25/24/23.98 /P	SMPTE ST 372	
		30/29.97/25/24/23.98 /PsF	SMPTE ST 425-1	
		30/29.97/25/24/23.98 /PsF	SMPTE ST 2048-2	
XYZ 4:4:4	12bit	2048×1080	30/25/24 /P	SMPTE ST 372
			30/25/24 /PsF	SMPTE ST 425-1

* The phase difference between links of HD(DL) is automatically corrected and displayed to 100 clocks (about 1.34 μs).

3G-B-DS video signal format and standard

Color System	Quantization	Image	Frame (Field) Frequency / Scanning	Compliant Standard
YCbCr 4:2:2	10bit	1920×1080	60/59.94/50 /I	SMPTE ST 274
			30/29.97/25/24/23.98 /P	SMPTE ST 425-1
		1280×720	60/59.94/50/	SMPTE ST 296
			30/29.97/25/24/23.98 /P	SMPTE ST 425-1

12G video signal format and standard (2 sample interleave)

Color System	Quantization	Image	Frame Frequency / Scanning	Compliant Standard
YCbCr 4:2:2	10bit	3840×2160	60/59.94/50 /P	SMPTE ST 2036-1 SMPTE ST 2082-10
			48/47.95/P	-
		4096×2160	60/59.94/50/48/47.95 /P	SMPTE ST 2036-1 SMPTE ST 2082-10
	12bit	3840×2160	30/29.97/25/24/23.98 /P	SMPTE ST 2036-1 SMPTE ST 2082-10
			4096×2160	30/29.97/25/24/23.98 /P
		4096×2160	30/29.97/25/24/23.98 /P	SMPTE ST 2036-1 SMPTE ST 2082-10
YCbCr 4:4:4	10bit	3840×2160	30/29.97/25/24/23.98 /P	SMPTE ST 2036-1 SMPTE ST 2082-10
			4096×2160	30/29.97/25/24/23.98 /P
		12bit	3840×2160	30/29.97/25/24/23.98 /P
	12bit	3840×2160	30/29.97/25/24/23.98 /P	SMPTE ST 2036-1 SMPTE ST 2082-10
			4096×2160	30/29.97/25/24/23.98 /P
		4096×2160	30/29.97/25/24/23.98 /P	SMPTE ST 2036-1 SMPTE ST 2082-10
RGB 4:4:4	10bit	3840×2160	30/29.97/25/24/23.98 /P	SMPTE ST 2036-1 SMPTE ST 2082-10
			4096×2160	30/29.97/25/24/23.98 /P
		12bit	3840×2160	30/29.97/25/24/23.98 /P
	12bit	3840×2160	30/29.97/25/24/23.98 /P	SMPTE ST 2036-1 SMPTE ST 2082-10
			4096×2160	30/29.97/25/24/23.98 /P
		4096×2160	30/29.97/25/24/23.98 /P	SMPTE ST 2036-1 SMPTE ST 2082-10

* It corresponds to TYPE 1 of 12G-SDI.

3G(DL)-2K video signal format and standard

Color System	Quantization	Image	Frame (Field) Frequency / Scanning	Compliant Standard
YCbCr 4:2:2	12bit	1920×1080	60/59.94/50 /P	SMPTE ST 274 SMPTE ST 425-3
			48/47.95 /P	-
		2048×1080	60/59.94/50/48/47.95 /P	SMPTE ST 2048-2 SMPTE ST 425-3
YCbCr 4:4:4	10bit	1920×1080	60/59.94/50 /P	SMPTE ST 274 SMPTE ST 425-3
			2048×1080	60/59.94/50/48/47.95 /P
		12bit	1920×1080	60/59.94/50 /P
	12bit	2048×1080	60/59.94/50/48/47.95 /P	SMPTE ST 2048-2 SMPTE ST 425-3
			60/59.94/50/48/47.95 /P	SMPTE ST 2048-2 SMPTE ST 425-3
		2048×1080	60/59.94/50/48/47.95 /P	SMPTE ST 2048-2 SMPTE ST 425-3
RGB 4:4:4	10bit	1920×1080	60/59.94/50 /P	SMPTE ST 274 SMPTE ST 425-3
			2048×1080	60/59.94/50/48/47.95 /P
		12bit	1920×1080	60/59.94/50 /P
	12bit	2048×1080	60/59.94/50/48/47.95 /P	SMPTE ST 2048-2 SMPTE ST 425-3
			60/59.94/50/48/47.95 /P	SMPTE ST 2048-2 SMPTE ST 425-3
		2048×1080	60/59.94/50/48/47.95 /P	SMPTE ST 2048-2 SMPTE ST 425-3

* The phase difference between links of) is automatically corrected and displayed to 100 clocks (about 0.67 μs).

* Links correspond to 3G-A, 3G-B-DL.

3G(DL)-4K video signal format and standard(Square)

Color System	Quantization	Image	Frame Frequency / Scanning	Compliant Standard
YCbCr 4:2:2	10bit	3840×2160	30/29.97/25/24/23.98 /P	SMPTE ST 425-3 SMPTE ST 2036-1
			30/29.97/25/24/23.98 /PsF	-
		4096×2160	30/29.97/25/24/23.98 /P	SMPTE ST 425-3 SMPTE ST 2048-1
			30/29.97/25/24/23.98 /PsF	-

3G(DL)-4K video signal format and standard(quad)

Color System	Quantization	Image	Frame Frequency / Scanning	Compliant Standard
YCbCr 4:2:2	10bit	3840×2160	30/29.97/25/24/23.98 /P	SMPTE ST 425-3 SMPTE ST 2036-1
		4096×2160	30/29.97/25/24/23.98 /P	SMPTE ST 425-3 SMPTE ST 2048-1

* The phase difference between links of) is automatically corrected and displayed to 100 clocks (about 0.67 μs).

* Links correspond to 3G-B-DS.

HD(QL) video signal format and standard

Color System	Quantization	Image	Frame Frequency / Scanning	Compliant Standard
YCbCr 4:2:2	10bit	3840×2160	30/29.97/25/24/23.98 /P	-
			30/29.97/25/24/23.98 /PsF	-
		4096×2160	30/29.97/25/24/23.98 /P	-
			30/29.97/25/24/23.98 /PsF	-

* 2K model requires SER 28 separately.

* The phase difference between links of) is automatically corrected and displayed to 100 clocks (about 0.67 μs).

3G(QL) video signal format and standard (square)

Color System	Quantization	Image	Frame Frequency / Scanning	Compliant Standard	
YCbCr 4:2:2	10bit	3840×2160	60/59.94/50 /P	SMPTE ST 425-5 SMPTE ST 2036-1	
			48/47.95 /P	-	
			60/59.94/50/48/47.95 /P	SMPTE ST 425-5 SMPTE ST 2048-1	
		4096×2160	60/59.94/50/48/47.95 /P	SMPTE ST 425-5 SMPTE ST 2048-1	
			30/29.97/25/24/23.98 /P	SMPTE ST 425-5 SMPTE ST 2036-1	
			30/29.97/25/24/23.98 /PsF	-	
	12bit	3840×2160	30/29.97/25/24/23.98 /P	SMPTE ST 425-5 SMPTE ST 2036-1	
			30/29.97/25/24/23.98 /PsF	-	
			30/29.97/25/24/23.98 /P	SMPTE ST 425-5 SMPTE ST 2048-1	
		4096×2160	30/29.97/25/24/23.98 /P	SMPTE ST 425-5 SMPTE ST 2048-1	
			30/29.97/25/24/23.98 /PsF	-	
			30/29.97/25/24/23.98 /PsF	-	
YCbCr 4:4:4	10bit	3840×2160	30/29.97/25/24/23.98 /P	SMPTE ST 425-5 SMPTE ST 2036-1	
			30/29.97/25/24/23.98 /PsF	-	
			4096×2160	30/29.97/25/24/23.98 /P	SMPTE ST 425-5 SMPTE ST 2048-1
		12bit	3840×2160	30/29.97/25/24/23.98 /P	SMPTE ST 425-5 SMPTE ST 2036-1
				30/29.97/25/24/23.98 /PsF	-
				30/29.97/25/24/23.98 /PsF	-
	12bit	3840×2160	30/29.97/25/24/23.98 /P	SMPTE ST 425-5 SMPTE ST 2048-1	
			30/29.97/25/24/23.98 /PsF	-	
			30/29.97/25/24/23.98 /PsF	-	
		4096×2160	30/29.97/25/24/23.98 /P	SMPTE ST 425-5 SMPTE ST 2048-1	
			30/29.97/25/24/23.98 /PsF	-	
			30/29.97/25/24/23.98 /PsF	-	
XYZ 4:4:4	12bit	4096×2160	30/25/24 /P	SMPTE ST 425-5 SMPTE ST 428	
			30/25/24 /PsF	-	

3G(QL) video signal format and standard (2 sample interleave)

Color System	Quantization	Image	Frame Frequency / Scanning	Compliant Standard
YCbCr 4:2:2	10bit	3840 × 2160	60/59.94/50 /P	SMPTE ST 425-5 SMPTE ST 2036-1
		4096 × 2160	48/47.95 /P	-
	12bit	3840 × 2160	30/29.97/25/24/23.98 /P	SMPTE ST 425-5 SMPTE ST 2036-1
		4096 × 2160	30/29.97/25/24/23.98 /P	SMPTE ST 425-5 SMPTE ST 2048-1
YCbCr 4:4:4	10bit	3840 × 2160	30/29.97/25/24/23.98 /P	SMPTE ST 425-5 SMPTE ST 2036-1
		4096 × 2160	30/29.97/25/24/23.98 /P	SMPTE ST 425-5 SMPTE ST 2048-1
	12bit	3840 × 2160	30/29.97/25/24/23.98 /P	SMPTE ST 425-5 SMPTE ST 2036-1
		4096 × 2160	30/29.97/25/24/23.98 /P	SMPTE ST 425-5 SMPTE ST 2048-1
RGB 4:4:4	10bit	3840 × 2160	30/29.97/25/24/23.98 /P	SMPTE ST 425-5 SMPTE ST 2036-1
		4096 × 2160	30/29.97/25/24/23.98 /P	SMPTE ST 425-5 SMPTE ST 2048-1
	12bit	3840 × 2160	30/29.97/25/24/23.98 /P	SMPTE ST 425-5 SMPTE ST 2036-1
		4096 × 2160	30/29.97/25/24/23.98 /P	SMPTE ST 425-5 SMPTE ST 2048-1
XYZ 4:4:4	12bit	4096 × 2160	30/25/24 /P	SMPTE ST 425-5 SMPTE ST 428

* The phase difference between links of) is automatically corrected and displayed to 100 clocks (about 0.67 μs).

* Links correspond to 3G-A, 3G-B-DL.

IP input signal format (LV5600-SER05, LV7600-SER05)

Color System	Quantization	Image	Field Frequency / Scanning
YCbCr 4:2:2	10bit	720 × 487	59.94 /I
		720 × 576	50 /I
		1280 × 720	60/59.94/50 /P
		1920 × 1080	60/59.94/50 /P*
			60/59.94/50 /I

* Corresponding IP standard SMPTE ST 2022- 6, SMPTE ST 2110- 20.

External synchronize input terminal

Input terminal	BNC terminal
Number of input terminals	1 line 2 terminals
Input impedance	15 kΩ Passive loop through
Input return loss	30 dB or more (50 kHz to 30 MHz, 75 Ω termination)
Maximum input voltage	± 5 V (DC + peak AC)
Input signal	Ternary synchronization signal or NTSC/PAL black burst signal 10 Field ID correspondence
Function	SDI reference signal input for video signal waveform display and phase difference display, Waveform display of external synchronization signal

Headphone output terminal

Output terminal	LV5600 3.5 mm Mini jack 1 terminal (stereo) LV7600 standard jack 1 terminal (stereo)
Output signal	On the screen of the displayed audio signal, arbitrary 2 ch (Downmixed Lt, Rt is also acceptable)

Monitor output terminal

SDI output terminal

Function	Output screen for SDI monitor
Output terminal	BNC terminal
Number of output terminals	1
Output signal	Output liquid crystal display screen is output with HD, 3G-A, 3G-B-DL. 1920x1080 60, 59.94, 50 I/P, YCbCr 4:2:2 (10 bits)

TMD5 output terminal

Function	The displayed screen is output for HDMI monitor.
Output terminal	HDMI terminal
Number of output terminals	1
Signal format	Single Link T.M.D.S
DDC function	Not supported
HOT PLUG detection function	Not supported
Output signal	Output liquid crystal display screen is output. 1920x1080 60 P, 59.94 P, 50 P

Control terminal

USB terminal

Terminal shape	Standard A
Number of terminals	2
Standard	USB 2.0
Compatible device	USB memory, USB mouse, touch panel type monitor

For Ethernet terminal control

Approved standard	IEEE802.3
Supported protocols	TELNET, FTP, SNMP, HTTP, SNTF

Input/output terminals

RJ-45

Function Remote operation with an external PC or remote controller, File transfer, get status information

Types 10Base-T, 100Base-TX, 1000Base-T

Remote terminal

Terminal shape	D Sub 15 pins (female)
Number of terminals	1
Control signal	LV- TTL level (LOW active)
Function	Preset recall, input signal switching, alarm output, tally
Alarm output	When a format alarm, various errors, fan abnormality, or internal temperature occurs

RS-422/485 terminal (LV5600-SER 27/LV7600-SER 27)

Function	Reception of tally, camera ID, camera iris signal
Terminal shape	RJ-45
Number of terminals	2

Display (LV5600)	
Liquid crystal display	7 type TFT color liquid crystal
Resolution	1920x1080
Refresh rate	60 Hz, 59.94 Hz, 50 Hz (Free run or frequency synchronization to external synchronization signal)
Touch panel	Electrostatic capacity type touch panel
General specifications	
Environmental conditions	
Operating temperature range	0 to 40 ° C
Operating humidity range	85% RH or less (with no condensation)
Performance guarantee temperature range	10 to 30 ° C
Usage environment	Indoors
Usable altitude	up to 2,000 m
Overvoltage category	II
Pollution degree	2
Power supply	
Voltage	AC 90 to 250 V, 50/60 Hz
Power consumption	TBD W max.

Dimensions	
LV5600	215 (W)x132 (H)x300 (D) mm (No protruding part included)
LV7600	426 (W)x44 (H)x300 (D) mm (No protruding part included)
Weight	
LV5600	TBD kg max. (Including options, accessories not included)
LV7600	TBD kg max. (Including options, accessories not included)
Accessories	
Power cord	x1
Cover inlet stopper	x1
D sub 15 pin connector	x1
D sub 15 pin connector cover	x1
Manual (CR-ROM)	x1
D sub 37 pin connector	x1 (LV5600-SER03/LV7600-SER03)
D sub 37 pin connector cover	x1 (LV5600-SER03/LV7600-SER03)
Options	
Remote controller	LV7290 (Ethernet connection)
Rack mount adapter (for LV5600)	LR2560
10 GbE multimode SFP + transceiver	AFBR-709 SMZ
10 GbE single mode SFP + transceiver	AFCT-739SMZ
AC adapter	SPU61A-105

Accessories

LR2560, RACKMOUNT ADAPTER

The LR2560 is a dual rack mount adapter used to install LV5600 waveform monitors in a 19-inch EIA standard rack. It allows two LV5600s to be installed side by side.



SFP + Transceiver

(For LV5600-SER05/LV7600-SER05)
AFBR-709SMZ (10 GbE multi mode)
AFCT-739SMZ (10 GbE single mode)



LC2565, BLANK PANEL

The LC2565 is a blank panel for the LR2560 rack mount adapter. Use it when installing a single LV5600 waveform monitor in the LR2560.



LV5600

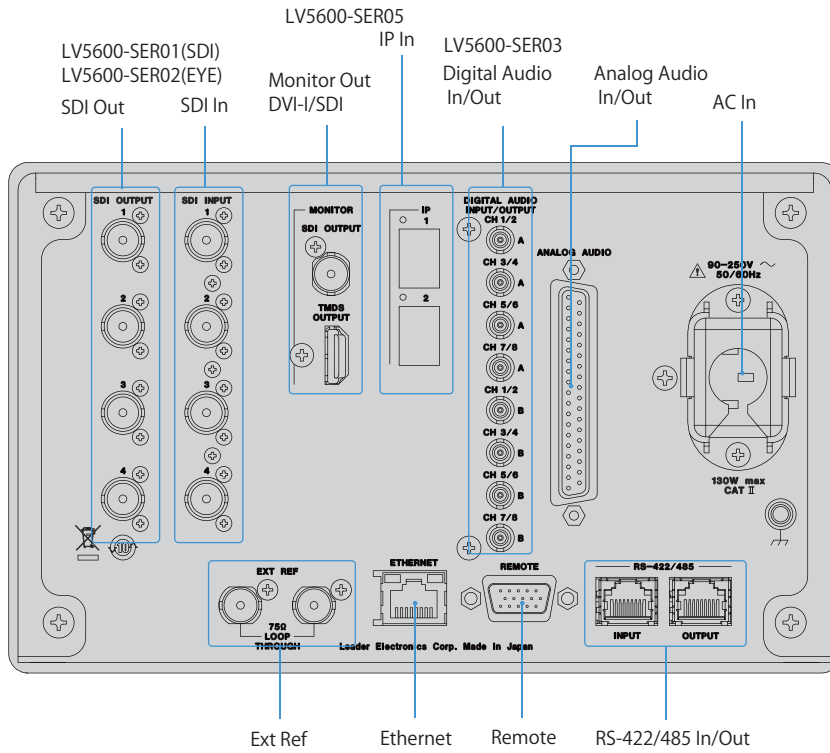

LV7600

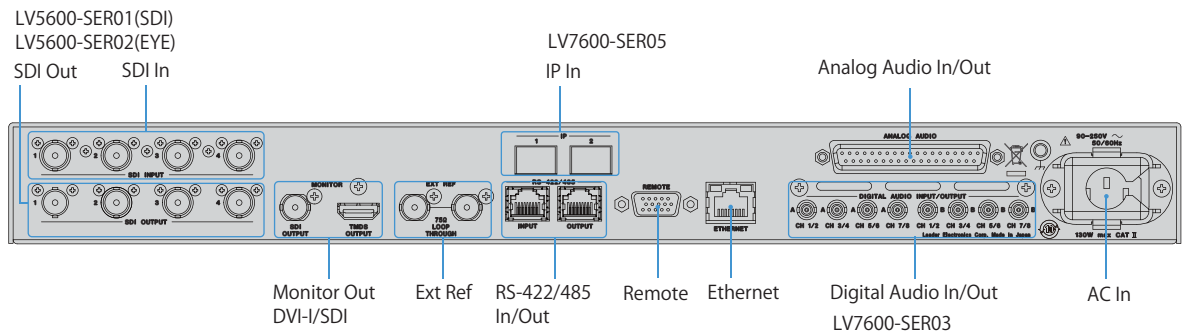

LV5600

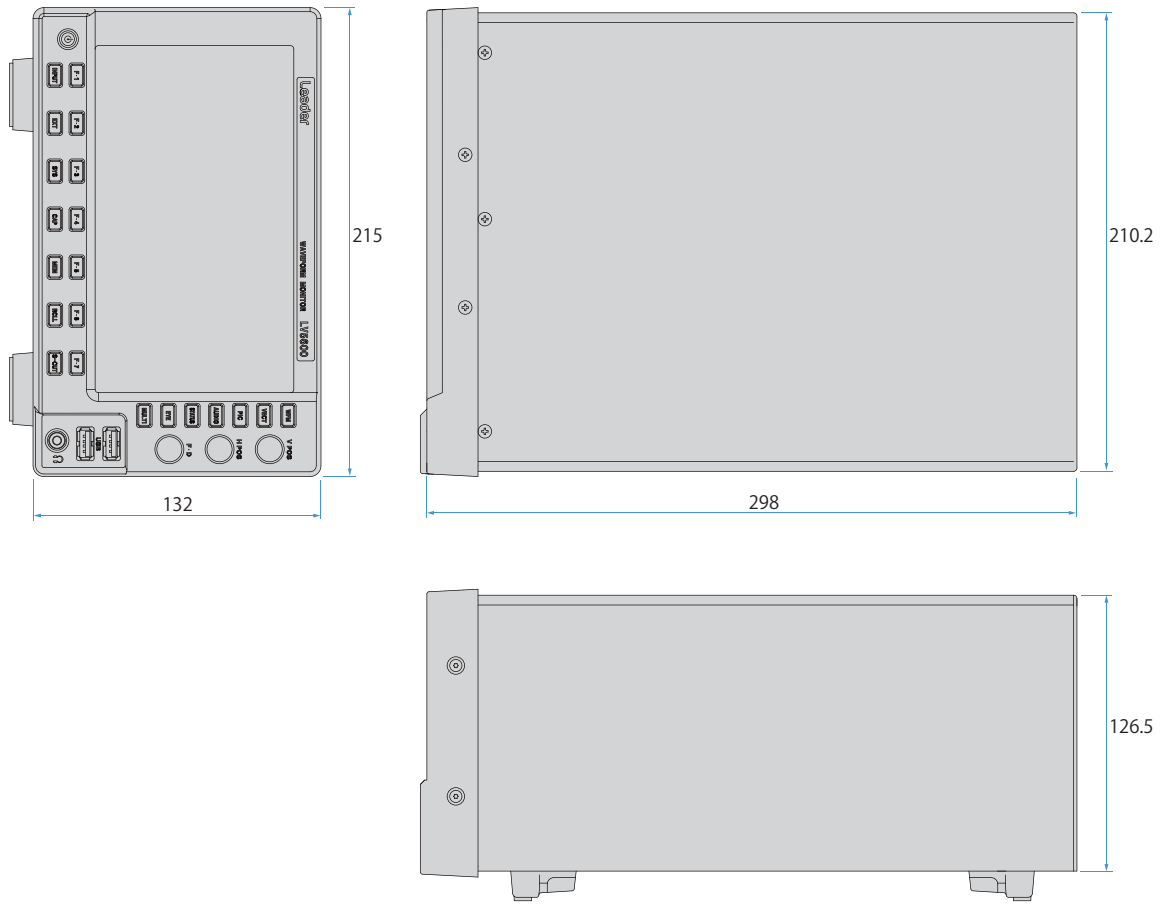

LV7600

